

Article number: 01020391

Description: Retaining ring J22 DIN472  
Stainless 411

## Measures

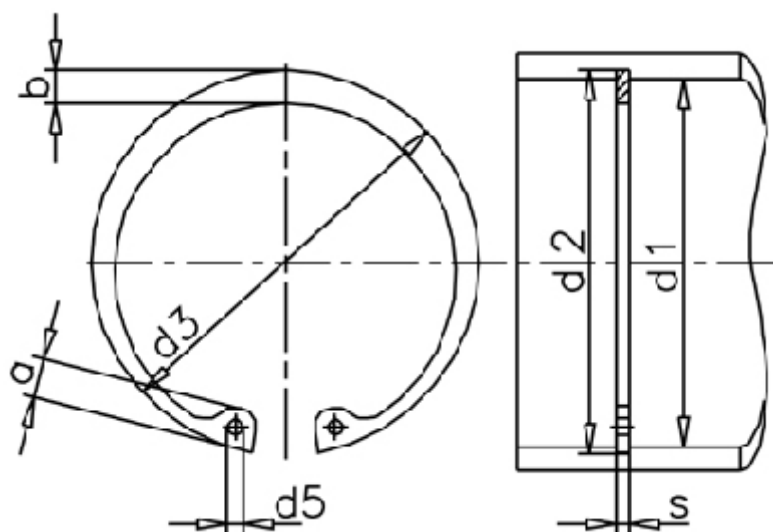

a max	= 4.2	FN kN	= 5.90	t	= 0.50
AN mm <sup>2</sup>	= 35.3	FRg kN	= 2.7	tol	= +0,13
b	= 2.5	FR kN	= 8.0	tol	= +0,42-0,13
d1	= 22	g	= 1.0	tol	= -0.06
d2	= 23.0	K kN-mm	= 17.6	Tong	= ZGJ-2
d3	= 23.50	m min	= 1.10	Weight kg/1000	= 1.10
d5 min	= 2.0	Nominal drive	= 1.5		
Description = J 22		s	= 1.00		